

Varenummer: 0106059
 Beskrivelse: Seeger låsering JV 42

Mål

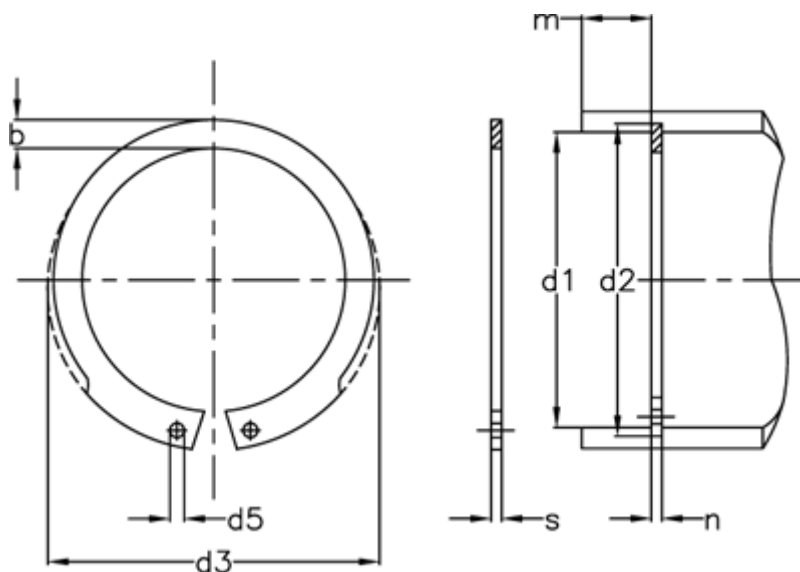

AN mm ²	= 85	FRg kN	= 8.5	Tang	= ZGJ-2
b	= 4.2	FR kN	= 45.5	tol	= -0.06
Betegnelse	= JV 42	g	= 2.0	tol	= +0,90-0,39
d1	= 42	K kN-mm	= 82.5	tol	= +0,25
d2	= 44.5	m min	= 1.85	tol	= 0.2
d3	= 45.5	Nominel træk	= 3.8	vægt kg/1000	= 5.20
d5 min	= 2.0	s	= 1.75		
FN kN	= 14.10	t	= 1.25		